

477 18

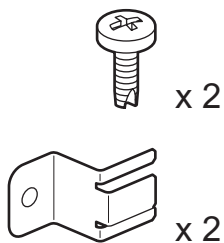

477 19/20/21

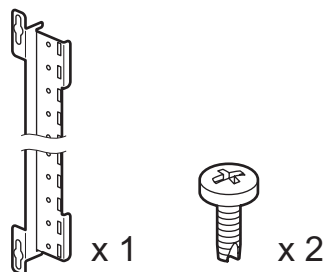

477 18

1

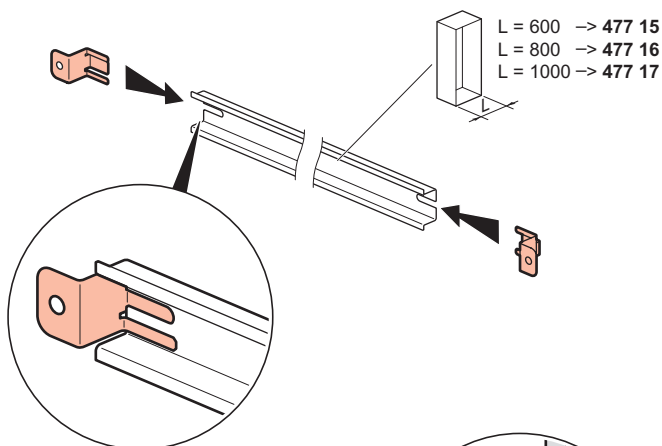

2

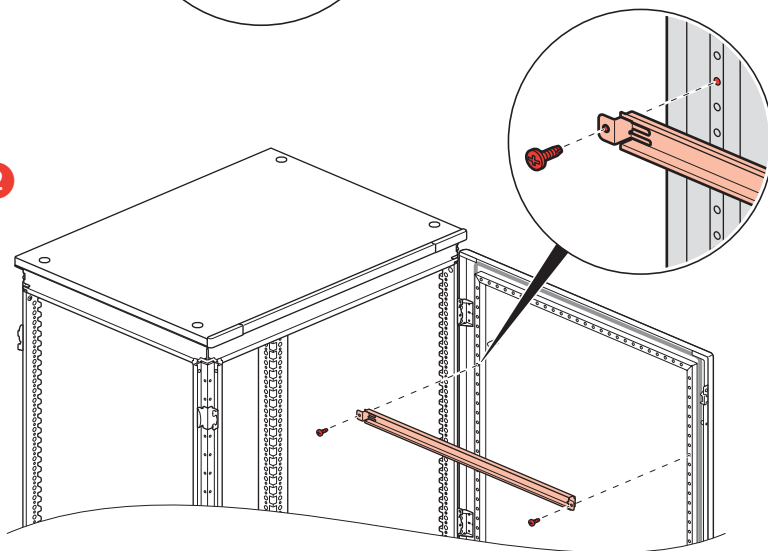

(A) + (B)

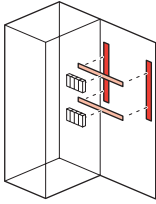

(B) + (A)

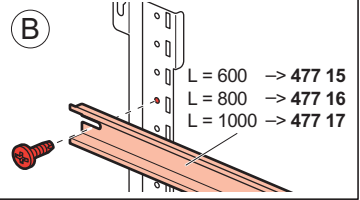
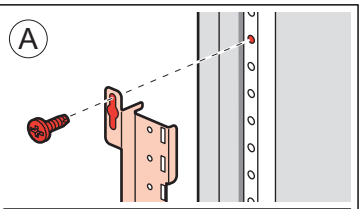
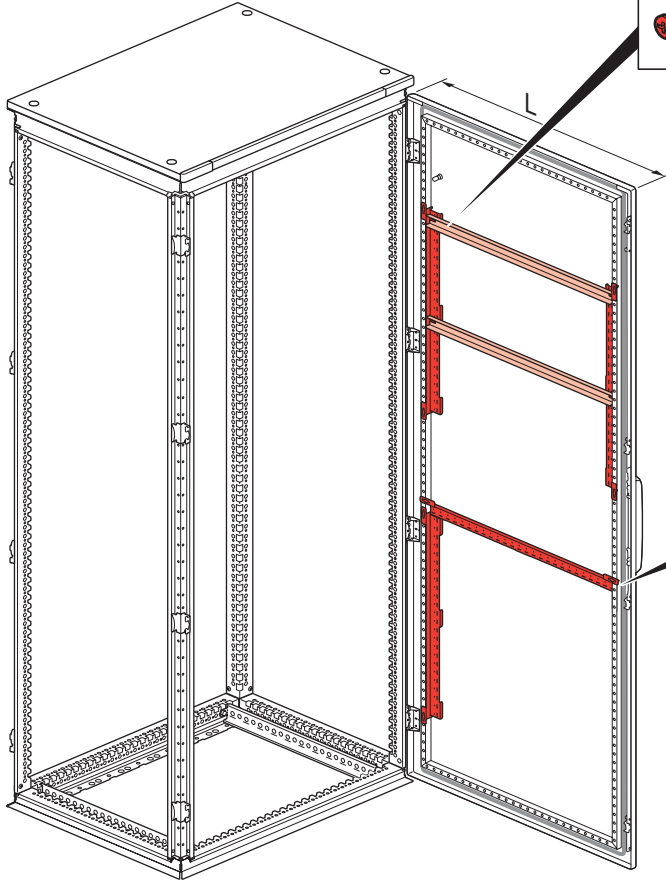
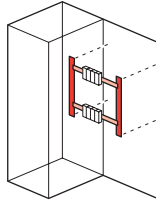

L = 600 → 477 15  
 L = 800 → 477 16  
 L = 1000 → 477 17

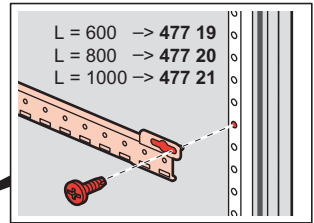

L = 600 → 477 19  
 L = 800 → 477 20  
 L = 1000 → 477 21

